

SPECIFICATION

1. PHYSICAL DIMENSION(UNIT: m/m):

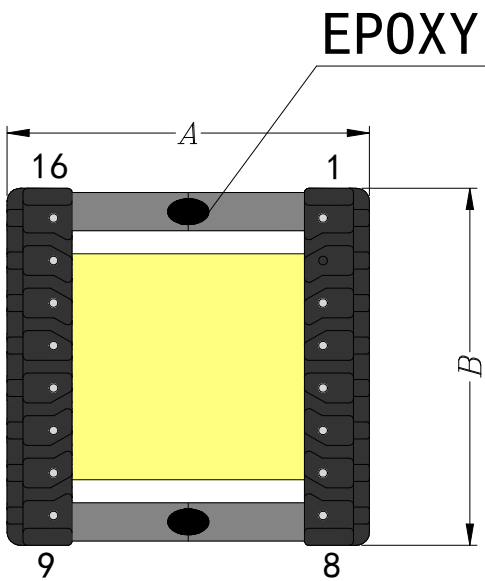
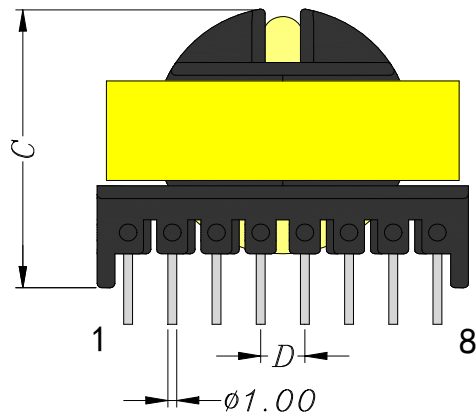
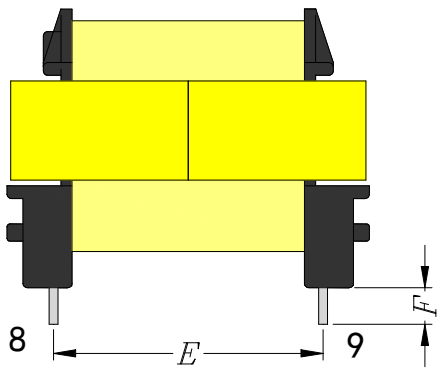

NOTE: PIN2 CUT OFF 2/3

- ※ DIMENSIONS WITHOUT TOLERANCE ARE APPROX
- ※ DIMENSION DOES NOT INCLUDE SOLDER USED ON COILS

LEAD FREE

DIM	A	B	C	D	E	F							
	MAX	MAX	MAX	+/-0.1	+/-0.1	+/-0.5							
SPEC	42.9	47.6	36.6	5.0	30.5	4.5							
							DESCRIPTION		TRANSFORMER				
							Customer P/N						
							FERRIWO P/N		FWPT-ETD39H-182K				
SPEC. NO.	PS-1001-010				PREPARED		APPROVED						

SPECIFICATION

2.WINDING TABLE:

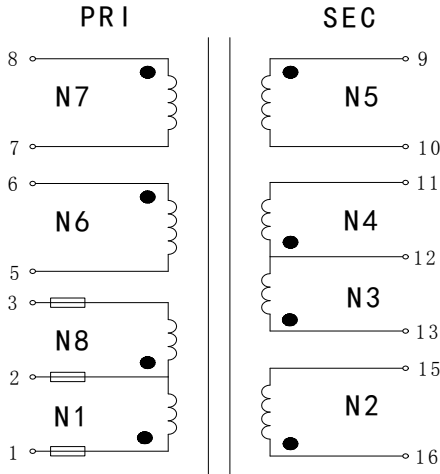

3.WINDING:

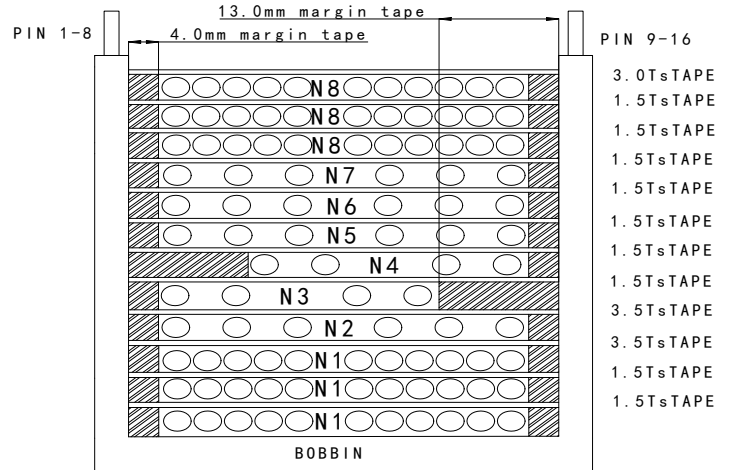

4.WINDING TABLE:

Winding NO.	Margin Tape	PIN	Wire & Wire Copper	Turns	Winding Type	Tape Layer	Tube
N1	F=S=4.0mm	1~2			Compact	1.0 1.0 1.0 3.0	F=S≈10.0mm
N2	F=S=4.0mm	16~15			Dispersed	3.0	
N3	F=4.0mm S=13.0mm	13~12			Dispersed	1.2	
N4	F=13.0mm S=4.0mm	12~11			Dispersed	1.2	
N5	F=S=4.0mm	9~10			Dispersed	1.2	
N6	F=S=4.0mm	6~5			Dispersed	1.2	
N7	F=S=4.0mm	8~7			Dispersed	1.2	
N8	F=S=4.0mm	2~3			Compact	1.0 1.0 1.0 3.5	F=S≈10.0mm

NOTE:

1. Products should be vacuum varnish

*VARNISH RATIO: 1:1

*VACUUM TIME: 15~20minutes

*BAKED TEMPERATURE : 120°C±10°C , 1~1.5hours

LEAD FREE



DESCRIPTION

TRANSFORMER

Customer P/N

FERRIWO P/N

FWPT-ETD39H-182K

SPEC. NO.

PS-1001-010

PREPARED

APPROVED

SPECIFICATION

5. ELECTRONICAL CHARACTERISTIC:

TEST CONDITION : TEMPERATURE AT 25°C
HUMIDITY AT 65 ±5% RH

TEST ITEM	TEST CONDITION	RESULT
INDUCTANCE CH-3250	@1.0KHz,0.25V (1~3) (5~6) (7~8) (9~10) (11~12) (12~13) (15~16)	1.8mH±10% 15.7uH±10% 15.7uH±10% 15.7uH±10% 2.5uH±10% 11.8uH±10% 17.0uH±10%
D.C.R CH-502	(1~3) (5~6) (7~8) (9~10) (11~12) (12~13) (15~16)	1120mΩ±15% 198mΩ±15% 196mΩ±15% 205mΩ±15% 64mΩ±15% 59mΩ±15% 73mΩ±15%
LEAKAGE INDUCTANCE CH-3250	@100KHz,0.25V (1~3)	65.0μH MAX SHORT OTHER PINS

LEAD FREE

	DESCRIPTION	TRANSFORMER	
	Customer P/N		
	FERRIWO P/N	FWPT-ETD39H-182K	
SPEC. NO.	PS-1001-010	PREPARED	APPROVED

SPECIFICATION

6. MATERIAL LIST :

ITEM		MATERIAL	SUPPLIER OR MANUFACTURER	TEMPRATING
1	CORE	FW40 OR EQUIVALENT	HAINING FERRIWO ELECTRONICS CO., LTD.	
2	BOBBIN	PHENOLIC OR EQUIVALENT	SUMITOMO BAKELITE CO., LTD. UL NO E41429	150°C
3	WIRE	UEW	PACIFIC ELECTRIC WIRE&CABLE(SHENZHEN) CO. LTD UL NO E84081	130°C
4	MARGIN TAPE	WF-2902	YAHUA STICKING TAPE CO.,LTD UL NO E324093	130°C
5	TAPE	CT280	YAHUA STICKING TAPE CO.,LTD UL NO E165111	130°C
6	VARNISH	R-1038	JOHN C DOLPH CO BC-346A UL NO E317427	130°C
7	FLUX	TF9100	LINAN GUITONG CHEMICAL TECHNICAL CO.,LTD	
8	TIN	Sn99.3Cu0.7	HAINING ZHUCHANG METAL FOIL CO;LTD	
9	TUBE	TEFLON TUBE	GREAT HOLDING INDUSTRIAL CO.,LTD UL NO E156256	200°C
10	EPOXY	E-500 (BLACK)	SUZHOU EATTO ELECTRONIC MATERIAL CO.,LTD UL NO E218090	130°C

LEAD FREE



	DESCRIPTION	TRANSFORMER	
	Customer P/N		
	FERRIWO P/N	FWPT-ETD39H-182K	
SPEC. NO.	PS-1001-010	PREPARED	APPROVED